

**00048718**

- Bulb for Rocker Switches

**09025157**

- Temporary option
- Rocker button
- NGR
- Blank

**00027301**

- Rocker button
- NGR
- W/L
- Select start

**00027288**

- Switch base
- NGR
- SPST
- On-off-momentary on

**00089174**

- Camera Switch Button

**0109836**

- Switch Base

**00027328**

- Rocker button
- NGR
- Service door (elec)

**00042456 (blue)****00042457 (blue)****00027292 (black)**

- Switch base
- NGR
- DPST
- Momentary on-off-momentary on

**00027349**

- Blank plug for switch panel
- NGR

**00049553**

- Blank plug for switch panel
- Actia
- NGR

**00027302**

- Rocker button
- NGR
- W/L
- Emergency override

**00027290**

- Switch base
- NGR
- DPST
- Off-on
- Red

**00027714**

- Switch base
- NGR
- DPST
- Off-momentary on
- Red

**00032198**

- Rocker button
- NGR
- Speaker int-ext

**00032480**

- Switch base
- NGR
- DPST
- On-on



**00027307**

- Rocker button
- NGR
- Stop arm hi/lo

**00027313**

- Rocker button
- NGR
- Dome rear

**00027308**

- Rocker button
- NGR
- Cross arm light

**00027314**

- Rocker button
- NGR
- Dome drivers

**00027309**

- Rocker button
- NGR
- Dome

**00027322**

- Rocker button
- NGR
- Destination sign

**00027310**

- Rocker button
- NGR
- Dome LH

**00027733**

- Rocker button
- NGR
- Clear lights

**00027311**

- Rocker button
- NGR
- Dome RH

**00027312**

- Rocker button
- NGR
- Dome front

**Common Base**

*(Used by the switches in this section.)*

**00027285**

- Switch base
- NGR
- SPST
- On-on high



**00027303**

- Rocker button
- NGR
- Stop arm cancel

**00027305**

- Rocker button
- NGR
- Cross arm cancel

**00027306**

- Rocker button
- NGR
- Stop/cross arm cancel

**Common Base**

*(Used by the switches in this section.)*

**00027289**

- Switch base
- NGR
- SPST
- Off-momentary on

**00027318**

- Rocker button
- NGR
- Heater master

**00027320**

- Rocker button
- NGR
- Strobe

**00029027**

- Rocker button
- NGR
- Door, rear

**Common Base**

*(Used by the switches in this section.)*

**00027294**

- Switch base
- NGR
- SPST
- On-on
- Ext ind

**00027327**

- Rocker button
- NGR
- Brake override

**00027650**

- Rocker button
- NGR
- W/L
- Cancel

**Common Base**

*(Used by the switches in this section.)*

**00027293**

- Switch base
- NGR
- SPST
- On-momentary off



**00027299**

- Rocker button
- NGR
- W/L
- Master
- Green

**00027325**

- Rocker button
- NGR
- Lift

**00027323**

- Rocker button
- NGR
- Chime

**00027331**

- Rocker button
- NGR
- Heater auxiliary

**Common Base**

*(Used by the switches in this section.)*

**00027287**

- Switch base
- NGR
- SPST
- IND
- Off-on

**00027332**

- Rocker button
- NGR
- Step de-ice

**00027581**

- Rocker button
- NGR
- W/L
- Master
- Red

**00074914**

- Noise Suppression Switch

**00074915**

- Rocker, Kill switch, noise suppression used if radio is on bus
- (Base 0074504) - Record

**00027319**

- Rocker button
- NGR
- Heater pump

*Aux Heater Byp*

**00027321**

- Rocker button
- NGR
- Heated mirror

**Common Base**

*(Used by the switches in this section.)*

**00027298**

- Switch base
- NGR
- SPST
- IND
- Off-on high



**00027315**

- Rocker button
- NGR
- Fan

**00027317**

- Rocker button
- NGR
- Heater, rear

**00027316**

- Rocker button
- NGR
- Heater, front

**00027324**

- Rocker button
- NGR
- Vent roof
- 2 speed

**00027330**

- Rocker button
- NGR
- Heater, driver's

**Common Base**

*(Used by the switches in this section.)*

**00027291**

- Switch base
- NGR
- SPST
- On-off-on high

**00029026**

- Rocker button
- NGR
- Heater, RH

**00027328**

- Rocker button
- NGR
- Service door (air)

**00027329**

- Rocker button
- NGR
- Exit door (air)

**Common Base**

*(Used by the switches in this section.)*

**00042458 (Blue)****00027296 (Black)**

- Switch base
- NGR
- SPST
- Momentary on-off-momentary on



**00027328**

- Rocker button
- NGR
- Service door (air)

**00042457 (Blue)****00035240 (Black)**

- Switch base
- NGR
- DPST
- On-on-on

**00027300**

- Rocker button
- NGR
- W/L
- Start

**00027295**

- Switch base
- NGR
- SPST
- Off-momentary on
- Amber

**00027328**

- Rocker button
- NGR
- Service door (electric)

**00027292**

- Switch base
- NGR
- DPST
- Momentary on-off-momentary on

**00027334**

- Indicator button w/ yellow & red light beside warning light start & master switch

**00027347**

- Bezel end
- NGR
- Switch panel

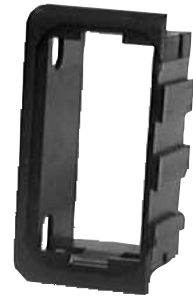
**00027321**

- Rocker button
- NGR
- Heated mirror

**00027297**

- Switch base
- NGR
- SPST
- IND
- Off-momentary on

**00027345 (Dome)****00027933 (Panel)****00042182 (Gauge)**

- Switch
- Slide
- Dimmer panel
- Gang mount
- 10A

**01808435**

- Connector



**00049555**

- Plate
- 4 gang switch

**00049554**

- Plate
- 3 gang switch

**00027348**

- Bezel center
- NGR
- Switch panel

**09025198**

- Temporary option
- Connector
- 10 circuit
- Switch
- Eaton

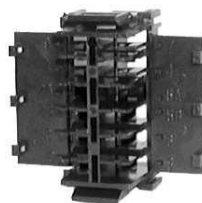
**01947100**

- Terminal

**09025199**

- Terminal

**01499094**

- Push-pull
- 3-position heater
- 3 terminals
- Defroster Switch

*Used until 1993 -  
replaced by  
04320925*

**01073311**

- Nut, hex, panel

TC/Driver Fan

**00236745**

- Emergency door and window buzzer
- 1 terminal

**00196394**

- Nut, adjusting

**01077718**

- Relay for Emer Door Buzzer

**02006187**

Older Busses

**01155241**

- Manual
- Push-button ON when in
- 2 terminals

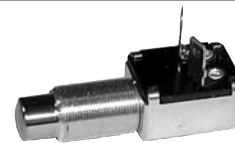
**01155258**

- Manual
- Push-button OFF when in
- 2 terminals

**01169408**

- Nut, hex, panel

**01499102**

- Push-pull
- 2-position accessory
- 2 terminals

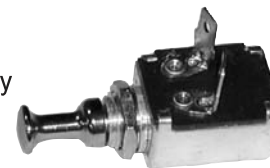
**01073311**

- Nut, hex, panel

**04320925**

- Htr Fan Switch SBCV

Strobe Light  
Defroster  
Q-Bus

**00367466**

- Push-pull
- Warning light system
- 4 terminals

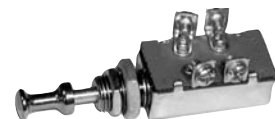
**01073311**

- Nut, hex, panel



**00367466**

- Push-pull
- Warning light system
- 4 terminals

**01073311**

- Nut, hex, panel

**02167393**

- Standard
- Push-out
- Window warning buzzer
- 1 terminal

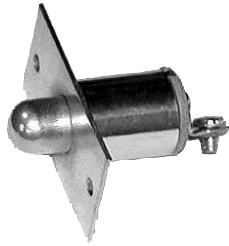

*Switch for Buzzer on  
Plowindow*

**01695154**

- Vertical hinge
- Push-out window

**01014349**

- Push-pull
- 3-position front heater
- Mini-Bird
- 3 terminals

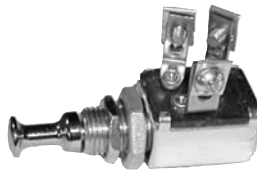
**01073311**

- Nut, hex, panel

**01145168**

- Adjustable
- Normally closed for rear emergency door or window buzzer
- 2 terminals

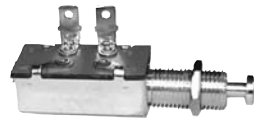

*7/16" Nut*

**01073311**

- Nut, hex, panel

**01126176**

- On when out
- 2 terminals

**00046112**

- Nut, hex, panel

**02100576**

- Warning lights
- 4 terminals

**02005981**

- Warning light
- 6 terminals

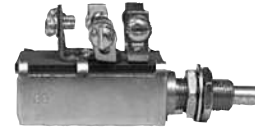
**00989020**

- On when out
- 4 terminals

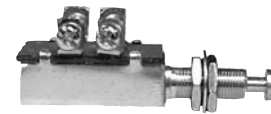
**01126184**

- Off when out
- 2 terminals

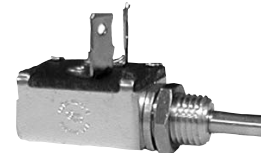
**02145449**

- Nut, hex, panel

**01124411** *Opt 2230*

- Adjustable
- On when out
- 4 terminals

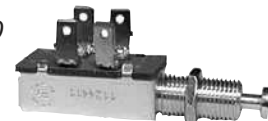
**01073311**

- Nut, hex, panel





**00648527**

- Warning light
- 8 terminals

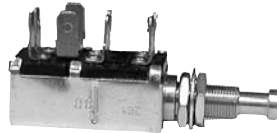
**02006088**

- On when out
- 2 terminals

**02006013**

- On when in
- 2 terminals

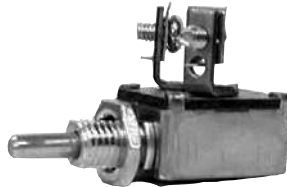
**02145449**

- Nut panel

**02101392**

- Vacuum Stop Arm Switch
- On when out
- 2-position
- 2 terminals

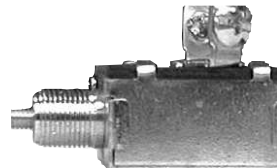
**02101400**

- Vacuum Stop Arm Switch
- On when out
- 3-position
- 2 terminals

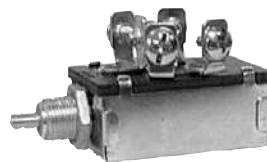
**00810002**

- 3-position with red knob

1655

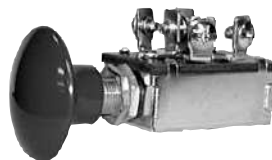
**00809996**

- 2-position with red knob
- Stop Arm

**01494913**

- 4 position heater
- 30 AMP

**01494897**

- Knob

TC/Defrost Control

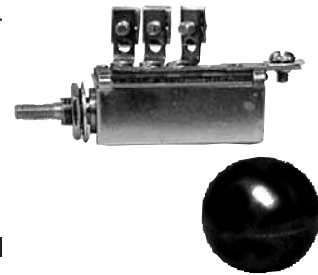
**08303141**

- Two speed
- Heater fan

CV Def 01838499

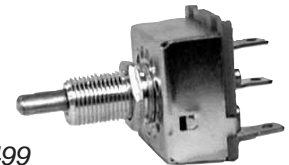
**04320917**

- Knob
- Heater switch
- Fresh Air

**08303158** Legacy

- Knob
- Heater switch
- Fresh Air
- 1 1/2" diameter

**00031531**

- Knob
- Temperature control
- Heater water
- 1 1/8" diameter

New

**00016333**

New Switch

**04320925**

- 3-speed
- Heater fan
- 5 Prong

TC/LTC

**08304081**

- Harness w/Door Switch

**01816727**

- Terminal

**08304099**

- Harness w/o Door Switch

**08312316**

Complete Wiring Harness

**01838499**

- Connector



**01962380**

- Low idle
- Adjustable

**01962364**

- Cruise control
- On/off

**01962372**

- Cruise control
- Set/resume

**01969997**

- Multi-function gauge

**01656487**

- High idle

**00833061**

- Foot-operated
- Momentary with lights

**02025245**

- Back-up light
- 2 terminals
- AA Auto Trans

**01143338**

- Battery disconnect

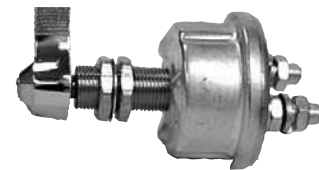
**01656396**

- Toggle
- On-on
- Rear engine control

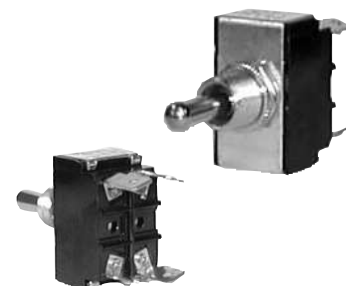
**00989186**

- Toggle
- 3-position
- Off-run momentary
- 4 terminals
- Spring Loaded

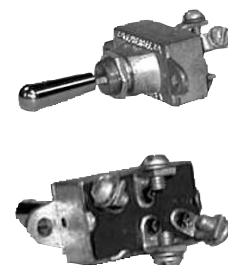

**02241438**

- Handi-lift
- Up-down
- Red
- 4 terminals

**02241446**

- Handi-lift ramp
- Up-down
- White
- 4 terminals

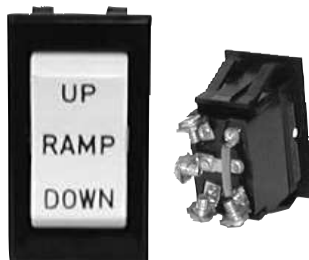
**00759902**

- Toggle with 1.5" lever
- 2 terminals

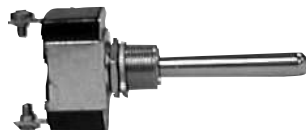
**00870485**

- Center off
- AARE
- 6 terminals

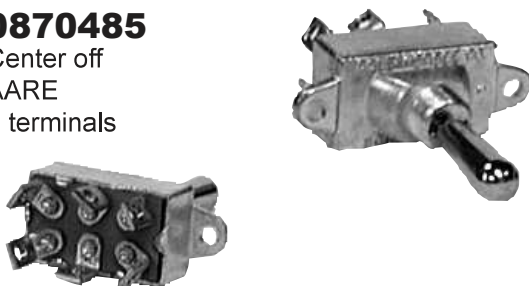
**02632529**

- Control
- Handi-lift
- 3 terminals

**00945410**

- Outside power
- Jackknife door
- 4 terminals

**00998740****01940873**

Switch Stop Light - Controls Warning Light

**00612895**

- Control
- Handi-lift
- 6 terminals

**00416628**

- Toggle
- On-off
- 6 terminals

**01004597**

- Toggle
- 12 terminals

**01124676**

- Headlight
- Dimmer

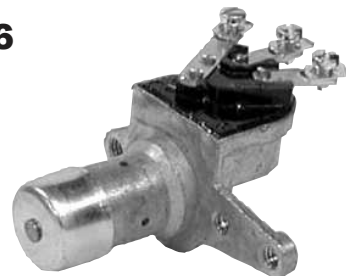
**00770339**

- Ignition
- Pollack 31-139

*Old Style*

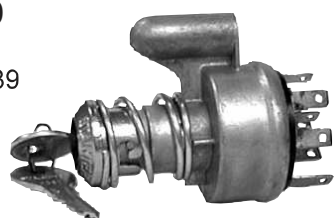

**01010685** • Ignition  
• Pollack 31-191

**04294849** • Key, blank

**01320969** • Connector  
• Ignition switch

**01320969** Connector

**01462993** • Ignition  
• Pollack  
• Keyed alike (key # D-250)



**00766121** • Term 10 GA

**00766121** Terminal

Q-Bus

**02028066** Term 14-16 GA

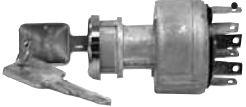
AA's TC '82 & up



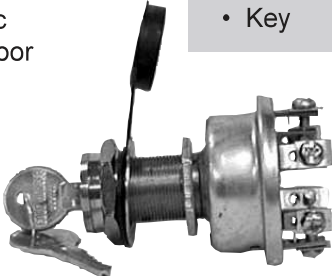

**01861806** • Electric  
• O/O Door  
• keyed

**08301244** • Key

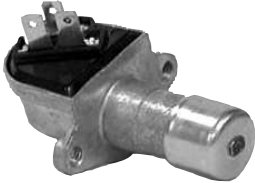

**01644525** • Headlight  
• Dimmer  
• TC/2000  
• 1994-1998



**01159375/00766162** • Connector

**02028066/00766121** • Terminal

**01861814** Door Switch by Handle

• Momentary  
• N/C  
• O/O  
• Electric door  
• Normally closed

3 Term  
40 Amp

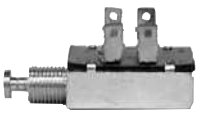

**01025782** • Emergency override  
• Includes knob  
• 5 terminals



**00952465** • Headlight

**01879931** • Nut  
• Headlight switch

**01355619** • Connector plugs into headlight switch

**01320951** • Connector

**02028066** • Terminator



**01659218** • Backup Light Switch



**01644749** • Headlamp and parking lamp  
• TC/2000  
• 1994-1998

**01833045** Connector Packard

*Headlight Switch*

**01831544** Terminal

**01469030** Diode



**01085083** • Rheostat  
• 2-pole

*Dimmer Switch that controls lights on Driver's Panel*

89 AAFC Domelite



**00907600** • Safety for Spicer transmissions  
• 2 terminals  
• AA Manual Trans



**01583699** • Key  
• O/S electric  
• Vandal lock (key not included)

**00848747** • Key



**06012165**

- Marquardt
- SPDT
- On-off-on

*Application Blue Bird  
Q-Bus*

**06012009**

- Arco Electric
- DPST
- Momentary on-off

*Application Blue Bird  
Q-Bus*

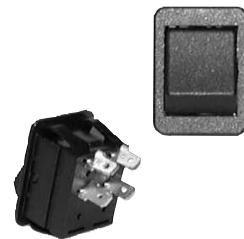
**01601814**

- Arco Elec
- SPST
- On-off
- 1550 sp

*Application Blue Bird  
Q-Bus*

**06012017**

- Arco Electric
- SPST
- On-off

*Application Blue Bird  
Q-Bus*

**01646587**

- Marquardt
- SPDT
- On-off-on

*Application Blue Bird  
Q-Bus*

**06012033**

- Arco Electric
- SPST
- On-momentary off

*Application Blue Bird  
Q-Bus*

**01646595**

- Marquardt
- SPST
- On-off

*Application Blue Bird  
Q-Bus*

**06012041**

- Arco Electric
- DPST
- On-off
- 12V lamp
- Red face

*Application Blue Bird  
Q-Bus  
BOAE Door Switch*

**06011985**

- Arco Electric
- DPDT
- On-off-on

*A/C Switch*

*Application Blue  
Bird Q-Bus*

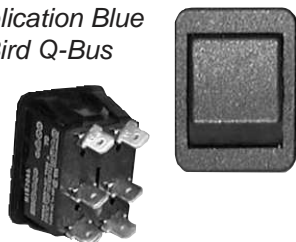
**06012058**

- Arco Electric
- DPST
- On-on
- 12V lamp
- Red face

*Application Blue Bird  
Q-Bus*

**06011993**

- Arco Electric
- DPST
- On-momentary off

*Application Blue Bird  
Q-Bus  
Brake Interlock*

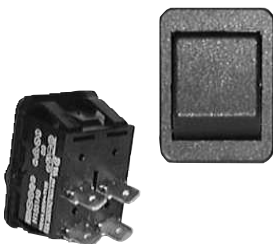
**06012025**

- Arco Electric
- SPST
- Momentary on-off

*Application Blue Bird  
Q-Bus*



**01943729**

- Bezel, End

**01943737**

- Bezel, Middle

**01947530**

- On-momentary off
- 2 terminals

*Application*  
Blue Bird  
MicroBird  
Strobe Lite

**01947548**

- Off-momentary on
- 2 terminals

*Application*  
Blue Bird  
MicroBird

**01947555**

- Off-on
- Amber pilot light
- 3 terminals

*Strobe Light*

*Application*  
Blue Bird  
MicroBird

**01947563**

- Off-on
- Red pilot light
- 3 terminals

*Application*  
Blue Bird  
MicroBird

**01947597**

- On-off-on
- Red/amber pilot lights
- 5 terminals

*Application*  
Blue Bird  
MicroBird

**01947605**

- Off-on
- 4 terminals

*Application*  
Blue Bird  
MicroBird

**01947522**

- Off-on
- 2 terminals

*Application*  
Blue Bird  
MicroBird

**01947571**

- Off-on-on without resistor
- SPDT

**01947589**

- Off-on-on with resistor
- SPDT

*Application*  
Blue Bird  
MicroBird



## SWITCHES TO FIT OTHER MAKES OF BUSES

**02133429**

- Rocker
- High-low-park
- 4 terminals

**02133452**

- Rocker
- High-low-off
- 6 terminals

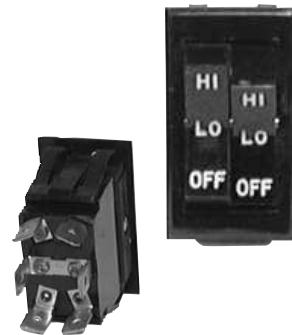
**02133445**

- Rocker
- On-off
- 4 terminals

**02133437**

- Rocker
- High-low-off
- 4 terminals

**02133411**

- Rocker
- On-off momentary
- 4 terminals

**02133460**

- Rocker
- On-off and momentary
- 4 terminals

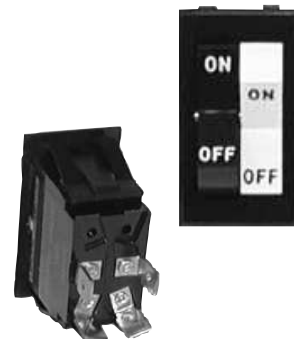
**02133478**

- Rocker
- High-low-off
- 3 terminals

**02133403**

- Rocker
- On-off
- 2 terminals



**02145878**

- Rocker switch
- Off-momentary on
- W/S washer
- 2 terminals

*Application  
Thomas*

**02145779**

- Rocker switch
- Hi-low-off split
- 3 terminals

*Application  
Thomas*

**02145795**

- Toggle switch
- Momentary warning light
- 6 terminals

*Application  
Thomas*

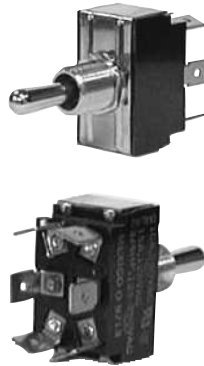
**02145746**

- Rocker switch
- Hi-low-off split
- 6 terminals

*Application  
Thomas*

**04312542**

- Toggle switch
- On-off with red light
- Warning lights
- 4 terminals

*Application  
Thomas*

**04297826**

- Blank switch

*Application  
Thomas*

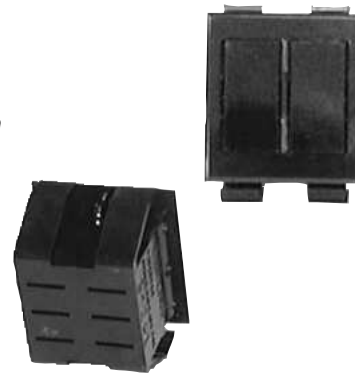
**02145753**

- Rocker switch
- On-off and split
- 2 terminals

*Application  
Thomas*

**02145761**

- Rocker switch
- On-off split
- 4 terminals

*Application  
Thomas*





**02145787**

- Paddle switch
- On-momentary off split
- 4 terminals

*Application  
Thomas*

**02147734**

- Toggle switch
- On-on-off heater
- 3 terminals

*Application  
Carpenter*

**04294351**

- Switch
- Momentary
- 2 terminals

**02147726**

- Toggle switch
- Hi-low-off
- W/S wiper
- 4 terminals

*Application  
Carpenter*

**02147742**

- Toggle switch
- On-off accessory
- 2 terminals

*Application  
Carpenter*

**02147759**

- Toggle switch
- Off-momentary on
- Warning lights and w/s wiper
- 2 terminals

*Application  
Carpenter*

**04297925**

- Toggle switch
- On-on-off
- Door
- 5 terminals

*Application  
Carpenter*

**04297917**

- Toggle switch
- On-off
- Master
- Lighted
- Red toggle
- 3 terminals

*Application  
Carpenter*



