

**00228072**

- Heater motor
- 12 volt
- 2-speed CW
- 2 -wire
- Self-ground
- Shaft: 1 3/8" x 5/16"

**00228080**

- Heater motor
- 12 volt
- 2-speed CCW
- 2 -wire
- Self-ground
- Shaft: 7/8" x 5/16"
- Rear Underseat
- Counterclockwise
- Used on AA & TC's up to 1992

**00159723**

- Heater motor
- 12 volt
- 2-speed CW
- 2-wire
- Self-ground
- Shaft: 11/8" x 5/16"
- Underseat Heater/Defroster
- Smaller RH Front

**01476183**

- Heater motor
- 12 volt
- PM
- CCW
- Shaft: 11/8" x 5/16"
- Heater in stepwell
- Front Heater
- Also 1991 - check eng opt

*Applications*

- TC/2000
- TC/1000
- CS Series
- TranShuttle 1992-97
- Q-Bus 1992-Present

**04316246**

- Heater defroster motor
- CW
- Shaft: 11/8" x 5/16"
- 2 speed or 3 speed

*Applications*

- 1995-97 Conventionals

**08303182**

- Blower assembly
- Front heater
- Double power



Kysor 18471

*Applications*

- TC/2000
- CS Series
- TranShuttle
- Conventional 1997-Present
- All American 1999-Present

**08307373**

- Blower motor
- Main Htr Fan Mtr

**08307365**

- Blower wheel

**00013477**

- Strap

**00014626**

- Grill, End

**08307241**

- Strap, Wall Heater

**08313223**

- Clip

**08307217**

- Housing

**04316295**

- Resistor

**01438480**

- Heater motor
- Driver's heater
- Shaft: 11/8" x 1/4"

*Applications 1989-Present*

**08307373**

- Blower motor
- Dual shaft:  
10" x 5/16"

**02004307**

- Fan blade
- 10"
- CCW

**02103323**

- Fan blade
- 5"
- Driver's heater
- Used until 1989

**02103414**

- Motor used w/ this fan

**01438126**

- Fan blade
- 5"
- Driver's heater
- Used 1989-Present

**01567288**

- Blower wheel
- Small
- Steel
- 2 7/8" H x 4 3/4" D
- 5/16" Shaft
- For Defroster

**01567270**

- Blower wheel
- Large
- Steel
- 2 7/8" H x 5 1/4" D

**01494905**

- Blower wheel
- Steel
- 3.79" H x 7.31" D

**04316543**

- Blower wheel
- Steel
- 3" H x 5 1/2" D

**04316337**

- Blower wheel
- Steel
- 3 1/2" H x 5 3/4" D

**01562131**

- 2 Inch AC Diff, Trans Air

**01407816**

- 3 Inch AC Diff,  
Trans Air

**08307365**

- Blower wheel
- Plastic
- 3 1/4" H x 5 1/4" D



**00530246**

- Diffuser
- Flat
- Black



**01915438**

- Diffuser assembly
- Adjustable
- 3"
- Takes 3 screws



**00530253**

- Diffuser
- Air
- Black



**01918549**

- Diffuser assembly
- Adjustable
- 3" without housing



**01563436 (1)**

- Louver
- Ball
- Q'Bus 1992-95



**01568948**

- Ring w/Hose Adpt

**01563428 (2)**

- Collar
- Mounting

**04310264 (1&2)**

- Ball and Collar

**01563444**

- Ring (for 2)

*3 Inch Opening  
2 Inch Hose*

**08303091**

- Louver heater
- 1 1/2 - 2 Inch Dash



**04316295**

- Resistor
- 3-speed
- Heater motor
- Dual Shaft

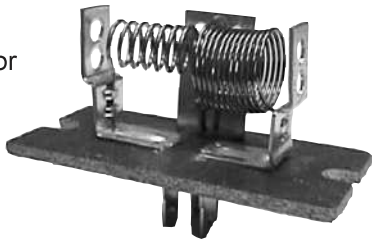

**01786060**

- Diffuser assembly
- Adjustable
- 3" for 2 1/2" hose
- Conventional 1995-96



**01787472**

- Plastic cover to hold diffuser

**01601681**

- Resistor
- 3-speed
- Heater motor
- CV

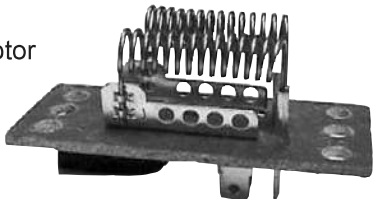

**01345669**

- Connector

**BERGSTROM PUMP**

00599-18471

*Makes a great replacement  
for Groco pumps!*

**01973981**

- Pump assembly
- Auxiliary water

**01973403\***

- Cover
- Auxiliary pump

**00020158**

- 90 Degree Tube

**01987676\*\***

- Plate
- Mounting  
auxiliary pump

**01973999**

- Has straight pipe

**02148849**

- Heater, Water  
Pump has  
straight pipe

**00007258**

- Bergstrom A3RE  
Feature 30058

**0869062****0869012**

- Bergstrom Lt

*\*Required when replacing Groco  
pump I/S Bus.*

*\*\*Required when replacing Groco pump  
in rear engine compartment.*

*Replace those leaking pumps  
with a quality-made,  
economical Bergstrom pump!*

**00952887**

- Auxiliary water pump  
assembly

CP20BB12V

Application Blue Bird

**Groco**

00198

**02103299**

- Motor only

**02103307**

- Seal kit

**02115780**

- Impeller

*\*Note: These service  
parts fit both Blue Bird  
and Wayne pumps.*

**01723071**

- Auxiliary water pump
- Plastic housing

**04324893**

- Motor only

**04324570**

- Repair kit

**01973999**

- Pump

**00054276**

- Seal Kit

**Groco****04297222**

- Auxiliary water pump

Application Wayne

**Groco****02103299\***

- Motor only

**02103307\***

- Seal kit

**02115780\***

- Impeller

*\*Note: These service  
parts fit both Blue Bird  
and Wayne pumps.*

**00666719**

- 6" auxiliary fan assembly
- 2-speed



**DCM**

**08314320**

- Motor, CCW
- 2-wire
- Self-ground
- Shaft: 5/8" x 1/4"

**08314312**

- Blade

**08314304**

- Guard kit
- Front and rear

**02105013**

- Base assembly

**01544220**

- 6" auxiliary fan assembly
- 2-speed
- Metal



**Baader-Brown**

**02143386**

- Motor, CW
- Defroster
- 2-speed

**08301954**

- Blade

**04316386**

- Heater filter
- Conventional
- 3/8" x 11" x 20 1/8"
- LH



**08303216**

- Heater filter
- Conventional
- 3/8" x 10" x 24"

**01922384**

- Heater filter
- 10" x 21.06" x 0.43"

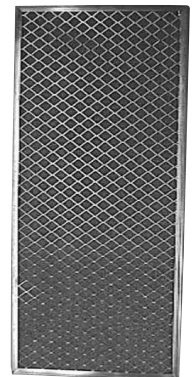

**01494962**

- Heater filter
- 10" x 20.15" x 0.43"

**00015895**

- AA 80000
- TC

**06003305**

- Filter
- Heater
- 1/4" x 10" x 10"



**FASCO**

**00935494**

- Defroster fan motor



**02115483**

- Defroster fan blade

**02146694**

- Defroster fan guard (front)

**08306060**

- Defroster fan guard (rear)

*Replace assembly with DCM fan.*

**01297761**

- Heater coil
- RH
- W/S
- Auxiliary
- Defroster
- 5/8" inlet and 5/8" outlet
- 5 1/4" x 5 5/8" x 1 7/8"

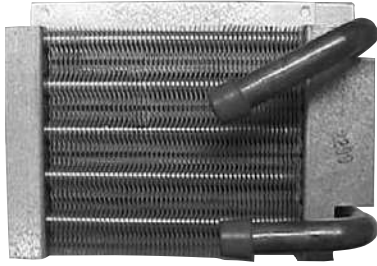
**02102705**

- Heater core assembly
- 12,000 BTU
- Driver's heater
- 2" x 6" x 8 1/2"
- Used until 1989

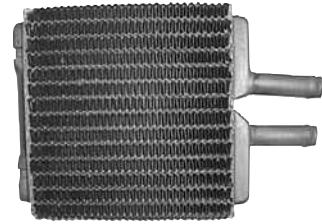
**01322494**

- Coil
- Front RH heater
- TC/2000
- 2 1/4" x 15" x 16 1/2"
- Used until 1991

**01294099**

- Heater coil
- 50,000 BTU
- RH front and underseat
- 2" x 9" x 16.2"

**02160562**

- Kit
- Converts old-type core unit to coil

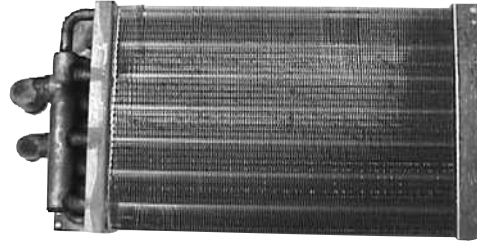
*Conventional***01294081**

- Heater coil
- 80,000 BTU
- Underseat
- 2" x 9" x 29.9"

**02157592**

- Kit
- Converts old-type core unit to coil

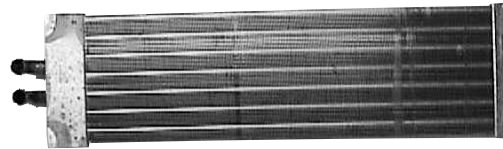
**01438118**

- Coil
- Driver's heater
- 2 1/2" x 5" x 7"
- Used 1989-Present

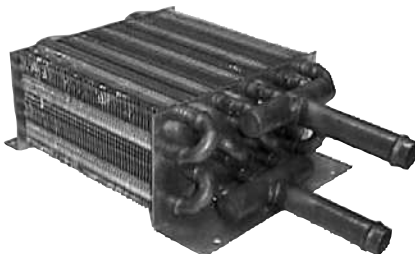
**08316374**

- Heater coil
- LH front heater
- Conventional
- Used 1997-2000

**00035914**

- Heater coil
- Used 2001-Present

**02149698**

- Coil, 25m Underseat (1023514)

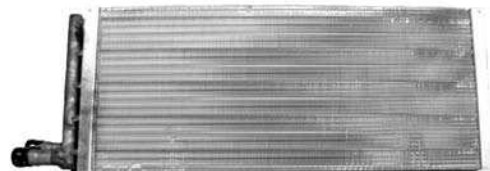

**01064997**

- Heater coil
- 80,000 BTU
- LH front
- Conventional
- 3" x 10 3/4" x 26 1/4"
- Used until 1994



**02129732**

- Kit
- Converts old-type core unit to coil

**01155977**

- Coil
- Front heater
- 90,000 BTU
- 3" x 10 3/4" x 25"

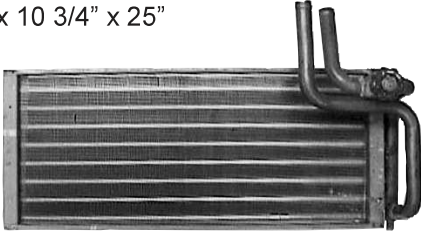

**04316378**

- Heater coil
- LH front heater
- SBCV
- 3 1/2" x 11" x 22"

*Application*  
1995-97

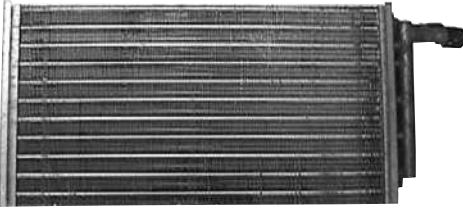

**01473511**

- Heater coil
- Front RH heater
- 3 1/2" x 10" x 22"

*Applications*

- 1991-96 TC/2000
- CS Series
- Q-Bus

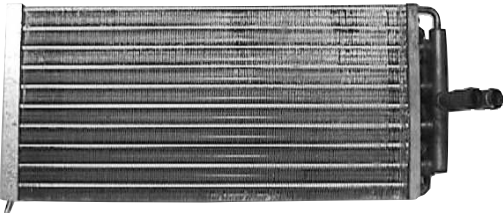

**01605542**

- Coil
- RH front heater
- 50,000 BTU
- 2" x 9" x 16.18"

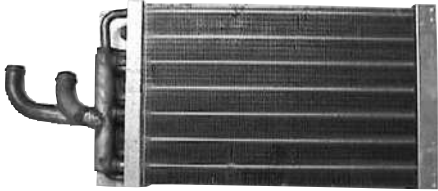

**01155969**

- Coil
- Front heater
- 90,000 BTU
- 3" x 10 3/4" x 25"



**08303208**

- Heater coil
- RH front heater
- 3 5/8" x 10" x 24"

*Applications*

- 1997-Present TC/2000
- CS Series



**08303109**

- Breaker
- 10 amp
- TC heater

**00601617**

- Clamp
- Heater hose
- Support

**01438811**

- Connector assembly
- Heater hose with 90 degrees
- KY

Image  
Not  
Available

**00244475**

- Valve assembly
- Straight
- 1"

**00250803**

- Valve assembly
- Heater
- Dual cut-off valve
- Soldered
- Cuts water onto heater beside driver's leg

**00544353**

- Valve
- Gate
- Heater
- Reamed
- 2 sided
- 1"

**00544361**

- Valve
- Gate
- Heater
- Reamed
- 1 side
- 1"

**01626431**

- Valve
- Ball
- 3/4"
- With butterfly handle

**04315065**

- Handle only

2000 SBW

**00651844**

- Valve
- Remote controlled
- Cable operated

**01420025**

- Cable
- Fresh air control AA

**01482736**

- Cable
- Heater control TC





**02052579**

- Valve assembly
- Gate
- 3/4"

1990 SBCV



**00571067**

- Tubing assembly
- With valve



**00810945**

- Brass elbow
- 90°
- With bleeder valve

**00810911**

- Bleeder screw



**00031322**

- Main Heater Water Valve Kit
- SBCV - New Ones



**00281303**

- Tubing only
- Brass elbow
- 90°



**00621664**

- Valve assembly
- Complete



**02115574**

- Brass Tubing
- 4 Inch Straight

**00878603**

- 1/4 Inch Compression, Cut-off Valve

**01605559**

- Valve assembly
- LH heater

*Application*  
GMCV 1992-94



**01360270**

- Tubing assembly
- Water supply/return
- RH WS defroster



**01203850**

- Tubing assembly
- With valve
- LH front heater



**01784628**

- Kit
- Water valve

*Application*  
GMCV 1995-96

**01913722**

- Kit
- Water valve

*Application*  
GMCV 1997-  
Present

**01784636**

- Kit
- Water valve

*Application*  
SBCV 1995-96

**01913730**

- Kit
- Water valve

*Application*  
SBCV 1997-  
Present

**00003459**

- Mounting bracket
- Seat cushion
- With U/S heater

**00069754**

- Heater assembly
- U/S
- 50,000 BTU
- Seat-mounted

**00069758**

- Heater assembly
- U/S
- 50,000 BTU
- Floor-mounted

**01294099**

- Heater coil

**00228072**

- Heater motor
- Rep by 0057157

**02004307**

- Heater fan

**00015894**

- Filter

**00007252**

- Screen, Protective

**01213651**

- Mtg Bracket

**00018903**

- Channel Adpt HR to Seat

**00069757**

- Heater assembly
- U/S
- 80,000 BTU
- Floor-mounted

**01294081**

- Heater coil

**00228072**

- Heater motor

**00069752**

- Heater assembly
- U/S
- 80,000 BTU
- Seat-mounted

**02004307**

- Heater fan

**00015895**

- Filter

**01444033**

- Heater assembly
- Driver's
- 12,000 BTU

**01438118**

- Heater coil

**01438480**

- Heater motor

**01438126**

- Heater fan



## FLEXIBLE DUCT HOSE

P/N	Description	Inside Diam (IN.)	Length (IN.)
01025261	Hose, Flex, Duct, 1.75 x 18	1.75	18
01025279	Hose, Flex, Duct, 1.75 x 48	1.75	48
01025287	Hose, Flex, Duct, 1.75 x 103	1.75	103
01025295	Hose, Flex, Duct, 2.5 x 34	2.5	34
01623248	Hose, Flex, Duct, 2.5 x 51	2.5	51
01508373	Hose, Flex, Duct, 2.5 x 7	2.5	7
01508381	Hose, Flex, Duct, 2.5 x 28	2.5	28
01623248	Hose, Flex, Duct, 2.5 x 48	2.5	48
01025303	Hose, Flex, Duct, 3 x 6	3	6
01025311	Hose, Flex, Duct, 3 x 18	3	18
01025329	Hose, Flex, Duct, 3 x 24	3	24
01025352	Hose, Flex, Duct, 3 x 103	3	103
01025360	Hose, Flex, Duct, 4 x 4	4	4
01251065	Hose, Flex, Duct, 4 x 45	4	45
01627090	Hose, FlexFlyte L1, 4 x 12	4	144
01248129	Hose, Flex, Duct, 5 x 18	5	18
01296235	Hose, Flex, Duct, 5 x 96	5	96
01493097	Hose, FlexFlyte L1, 5 x 12	5	144
01139872	Hose, FlexFlyte VF, 6 x 25	6	300
01451046	Hose, FlexFlyte VF, 6 x 18	6	18
01711787	Hose, Flex, Duct, 6 x 8	6	8

### 2102994

- Kit
- Retrofit
- Plumbing
- US heater

### 1" HEATER HOSE BY THE FOOT

02003317	Black
02003309	Red
01250760	Blue, Hy Miler
01143866	Silicone

## AIR CONDITIONING

Contact your Blue Bird Distributor for all your Air Conditioning parts needs.  
Ask for a copy of our A/C Parts Catalog!

4

H  
V  
A  
C

### 26-19912

- Dual wheel blower

Replaces  
Carrier 401-209  
and  
Trans Air  
412025



**Omega**

### 31-30957

- Expansion valve

Replaces  
Trans Air 210019



**Omega**

### 37-10866

- 30 cu. in. filter/drier



**Omega**

Replaces Trans Air 212010

### 25-11112

- 11" condenser fan

Replaces  
Carrier 401-110



**Omega**

### 31-30901-P

- Expansion valve

Replaces  
Carrier 101-107



**Omega**

### 25-14863-T

- 10" condenser fan



**Omega**

Replaces Trans Air 2160088

### 37-10865

- 16 cu. in. filter/drier



**Omega**

Replaces Carrier 101-303

## COMMON REPLACEMENT PARTS FOR TRANS AIR AND CARRIER

BLUE BIRD P/N	TRANS AIR P/N	CARRIER P/N
29-30120	111001	201-404
30-13331	112007	201-806
28-51601	113033	202-300
28-01713	412005	
26-19902	412019	
33-31961	111022	
29-21901	113006	201-305
37-10860-A	211004	101-200
28-31528	412012	401-301
26-14596	511002	
29-30104	111025	201-400
28-51602	113032	202-303
37-10870	212012	
28-21565	412014	
26-14522	511017	
20-10089		501-298
32-10905-E		201-501
28-31535		401-308
20-10838		502-216
33-31916		201-611
26-14595		501-102A
37-10868		14-00288-00

*Contact your  
Blue Bird Distributor  
for all your  
Air Conditioning  
parts needs.*

*Ask for a copy of our  
A/C Parts Catalog!*

### PREMIUM REFRIGERANT LUBRICANTS FOR R-134A A/C SYSTEMS

**41-50014-B**

- POE 100

**41-50102-B**

- PAG 46

**41-50104-B**

- PAG 100

**41-50106-B**

- PAG 100



**Omega**

**21-24801**

- A/C service kit
- R-12 and R-134A compatible
- Premium seals and O-rings

**Omega**



# 1997-2002 FORD E - SERIES VANS AND CUTAWAY BUSES

Contact your Blue Bird Distributor for all your Air Conditioning parts needs.  
Ask for a copy of our A/C Parts Catalog!

4

H  
V  
A  
C

## 29-33104

- Clutch cycle switch



Omega

## 26-13248

- Ford blower motor



Omega

## 24-31063

- Ford condenser

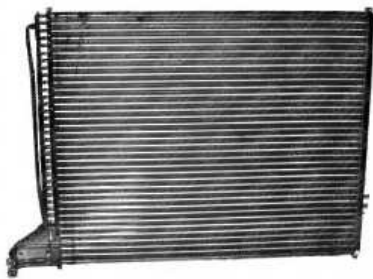

Omega

## 27-33161

- Ford evaporator

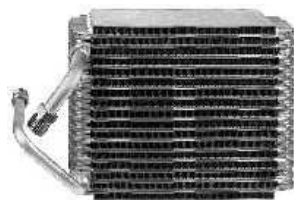

Omega

## 37-23441

- Ford accumulator



Omega

## 20-10778

- Ford FS10 compressor with clutch

## 20-10587

- Ford FS10 compressor without clutch



Omega



## 22-10504

- Clutch only

## 31-50003

- Red orifice tube



Omega

## 01525856

- Knob
- Lever

